

SUSTAINABLE COOLING SOLUTIONS

SECCO



Contents

About Secop	3
Core Businesses and Products	7
Beyond the Product	23
History and Milestones	29
Secop Today	33

ABOUT SECCOP

International Provider of:

- Hermetic reciprocating compressors
- Controllers for compressors
- Condensing units
- Refrigeration solutions

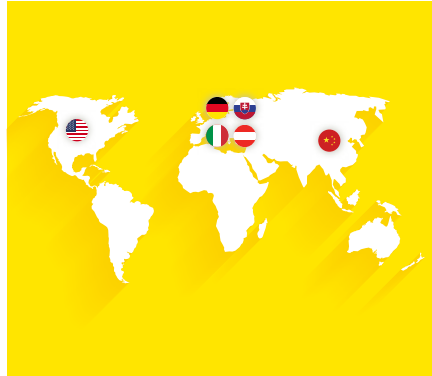

Our Markets Are:

- **Light Commercial**, AC-powered applications
- **Battery-Driven**, DC-powered and mobile applications
- **Medical Cooling**, stationary or mobile applications





Vision

Secop strives to be the first choice for partners searching for leading-edge refrigeration solutions and premium customer experience.



Mission

Secop is committed to delivering advanced refrigeration compressors and controls, offering customers tailored sustainable solutions for light commercial, battery-driven, and special cooling applications.



Values

- Perform with **PASSION**
- Deliver high **QUALITY**
- Act with **INTEGRITY**
- Work with **TEAM SPIRIT**

Integral to Your Success

These qualities make Secop an ideal partner for efficient cooling solutions:



Energy Efficient
"Green Solutions"



Hydrocarbon
Ready



Long Product
Life Cycles



Premium Controllers
for Compressors



Superior Product
Quality and Reliability



Variable-Speed
Compressors

CORE BUSINESSES AND PRODUCTS



Stationary Cooling

Refrigeration compressors and solutions for food retail, food service, medical, commercial freezers or coolers, beverage dispensers, special commercial equipment, and selected residential applications



Mobile Cooling

DC-powered or battery-driven compressors specifically designed for mobile cooling solutions: automotive (trucks, cars, bus), recreations vehicles, portable boxes, medical, solar, and special applications



Medical Cooling

Refrigeration compressors and solutions for various vaccine and biomedical cooling requirements including ultra-low temperature models for stationary or mobile appliances providing world-wide safe storage or transport at different temperature levels

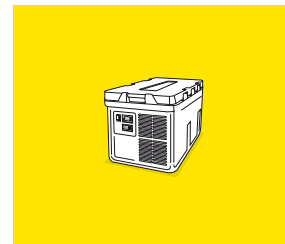
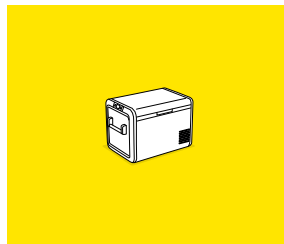



Stationary Cooling

The recipe for successful solutions:

- 60 years of experience
- Unparalleled reliability
- Efficient solutions
- Hydrocarbon optimized range
- Premium variable-speed drive
- Global service

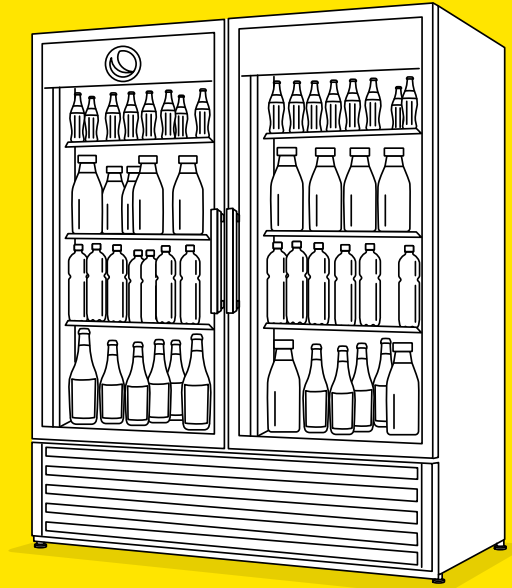



Variable-Speed
Drive



Energy
Optimized



Wide Application
Range



Natural
Refrigerants

Stationary Cooling

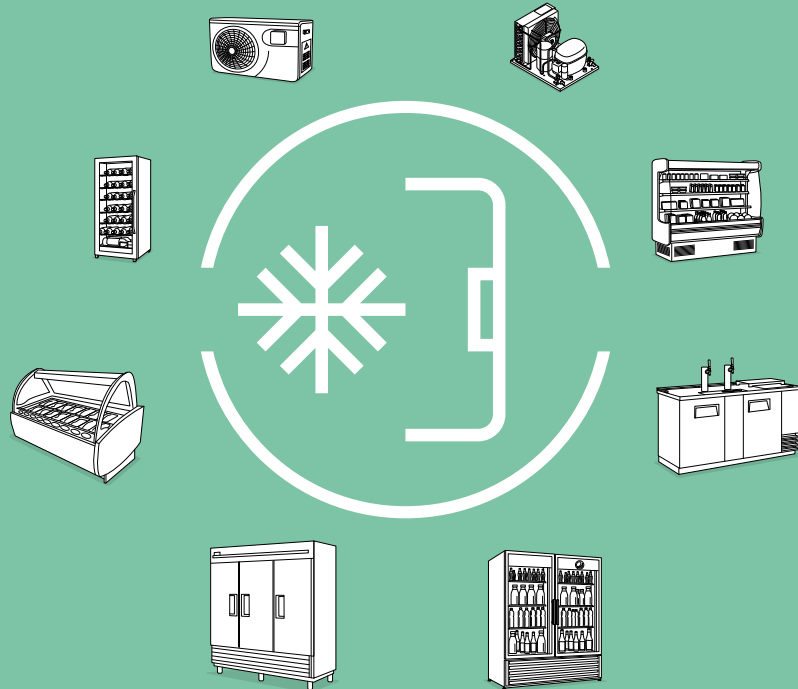

Stationary Cooling

Electronically Controlled Capacity

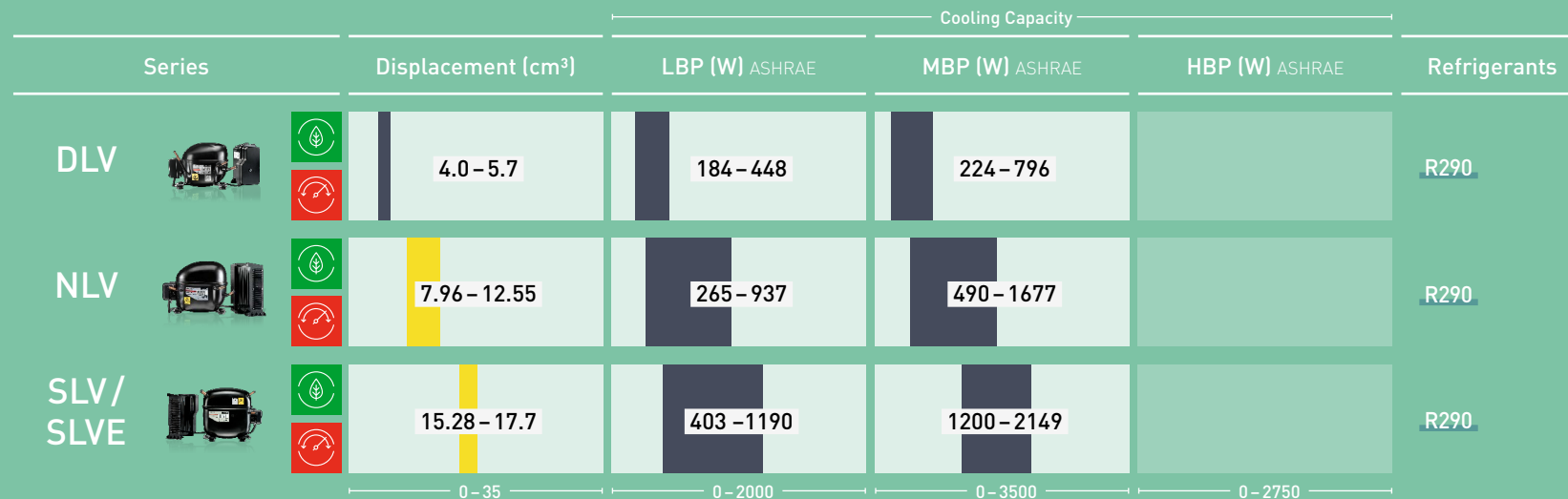

Stationary Cooling

Fixed-Speed

Series	Displacement (cm ³)	Cooling Capacity			Refrigerants
		LBP (W) ASHRAE	MBP (W) ASHRAE	HBP (W) ASHRAE	
P	1.41 – 2.50	25 – 59	66 – 126	130 – 192	R600a R134a
T	2.6 – 10.13	45 – 272	11 – 392	218 – 488	R600a R290 R134a R404A R513A R452A
D	4.0 – 10.14	62 – 382	324 – 678		R600a R290
K	5.6 – 12.5	92 – 260			R600a R134a
KL	4.0 – 7.7	200 – 395	401 – 704		R290 R134a

0 – 35 0 – 2000 0 – 3500 0 – 2750



Stationary Cooling

Fixed-Speed

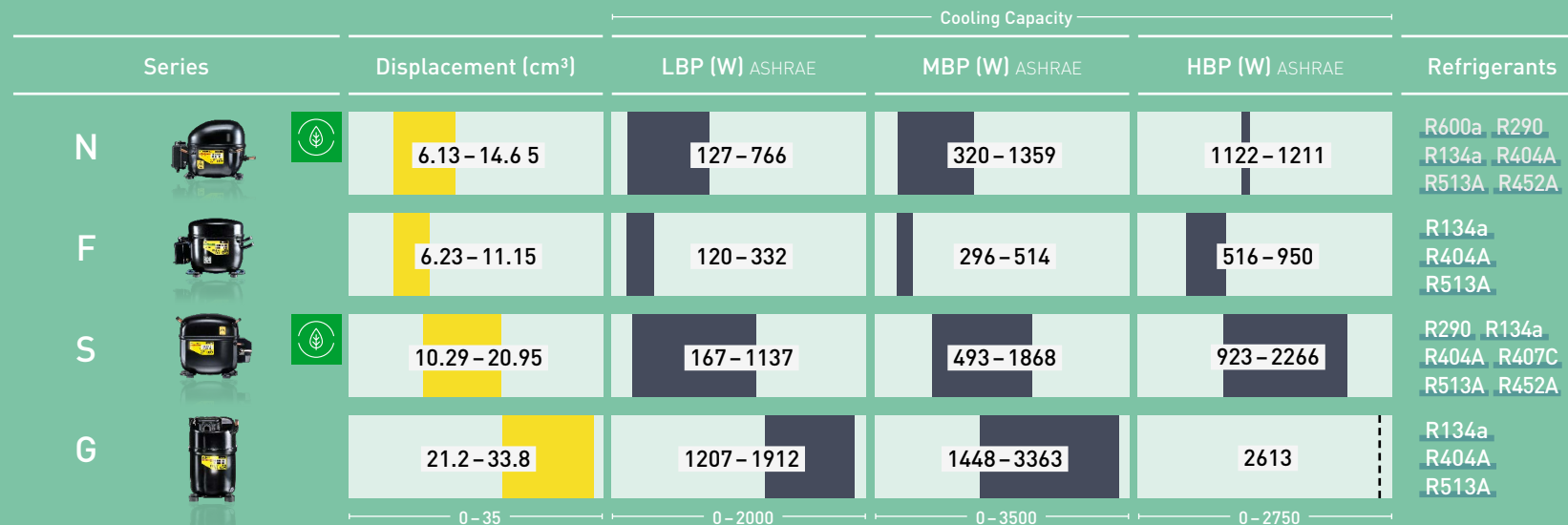



Mobile Cooling

Refrigeration anytime and anywhere:

- DC-powered compressors
- Pioneer with 40 years of experience in battery-driven mobile refrigeration solutions
- Reliable solutions (automotive standards)
- High performance in compact size
- Premium control electronics
- Global service

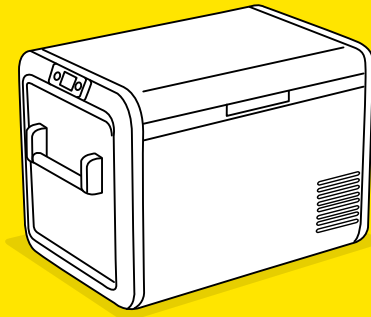

Mobile Cooling



Variable-Speed
Efficiency



Premium
Controllers



Low Noise
Low Vibration





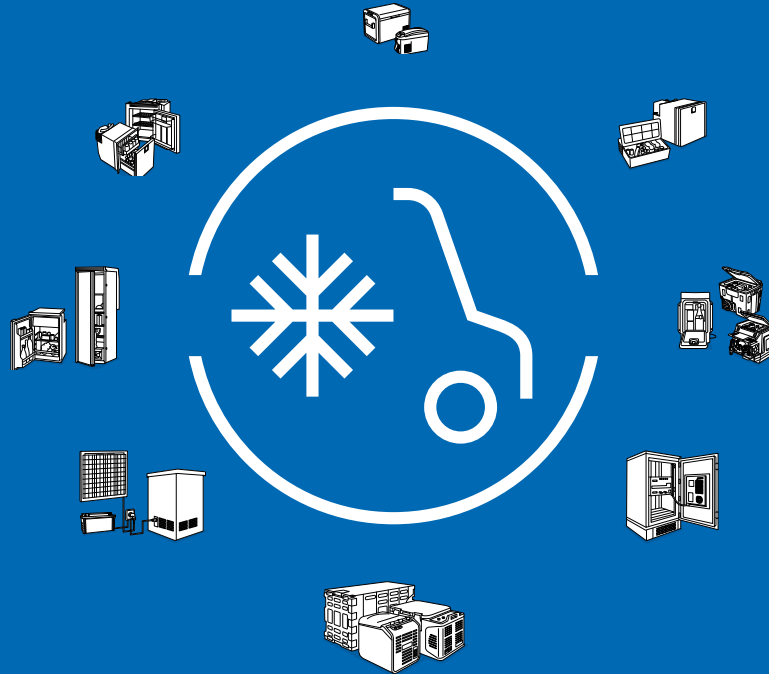





Low GWP
Refrigerants



Mobile Cooling

Product Portfolio

Series	Displacement (cm ³)	Cooling Capacity			Refrigerants
		LBP (W) ASHRAE	MBP (W) ASHRAE	HBP (W) ASHRAE	
BD Nano  <div style="display: flex; align-items: center;">   </div>	1.42 – 2.60	28 – 69	62 – 139		R134a R1234yf R600a
BD Micro  <div style="display: flex; align-items: center;">  </div>	1.41	13 – 34	42 – 94	83 – 173	R134a R1234yf
BD-P  <div style="display: flex; align-items: center;">   </div>	2.0 – 3.0	29 – 71	65 – 223	115 – 390	R600a R290 R134a
BD-T  <div style="display: flex; align-items: center;">  </div>	3.86 – 5.08	115 – 245	242 – 473	433 – 804	R134a R404A
	0 – 35	0 – 2000	0 – 3500	0 – 2750	

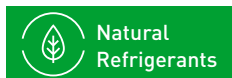

Natural Refrigerants



Variable-Speed Drive



Medical Cooling

Reliable stationary and mobile solutions:

- For stationary biomedical appliances
- Active mobile ULT compressor solutions
- Safe storage and transport in AC/DC mode
- SDD (Solar Direct Drive) solutions
- Used in applications officially certified by WHO
- Electronic controlled solutions
- Global service

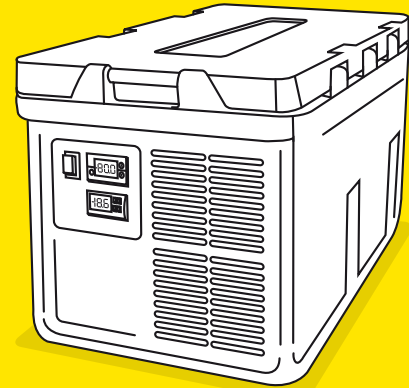



AC-Powered
Applications



DC-Powered
Applications



Energy
Optimized



Ultra Low
Temperature

Medical Cooling

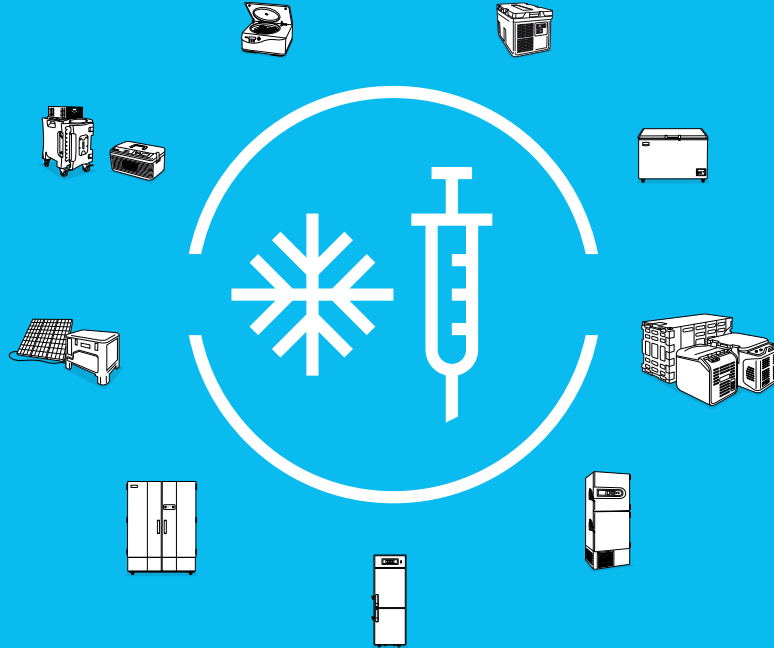



Medical Cooling

Product Portfolio

Applications	Evap. temp. range [°C]	Displacement (cm ³)	Cooling Capacity (W)	Test Conditions	Refrigerants
Medical Refrigerators Freezers	+2 to +8 -20 to -30	1.41 – 20.95	14 – 1100	ASHRAE LBP	R290 R600a R134a R513A R1234yf R404A R452A
Biomedical Freezers	-30 to -60	3.89 – 20.95	79 – 648	EN 12900 LBP	R290 HC Mixture R404A R452A
Ultra-Low Temperature Freezers	-60 to -90	2.0 – 20.95	22 – 356	pe=-90 °C pc=-35 °C Tsuc=-20 °C Tliq=-35 °C Tamb=32.2 °C	R170 HC-Mixture

0 – 35
0 – 1200



Secop recommends using 2-stage cascade systems for the temperature range from -60 °C to -90 °C. These have been developed for highest reliability and product safety at ultra-low temperatures.



Stationary Cooling

Condensing Units:

- Natural and alternative refrigerants
- Comply with the EU Ecodesign Directive
- Compact design for installation in tight spaces
- 100% quality control of every single unit
- Using energy-optimized compressors
- Global service

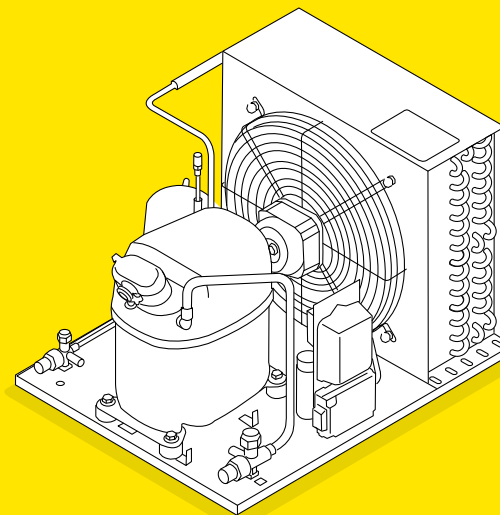



Natural
Refrigerants



EU Sustainable
Design



Alternative
Refrigerants



Wide Application
Range



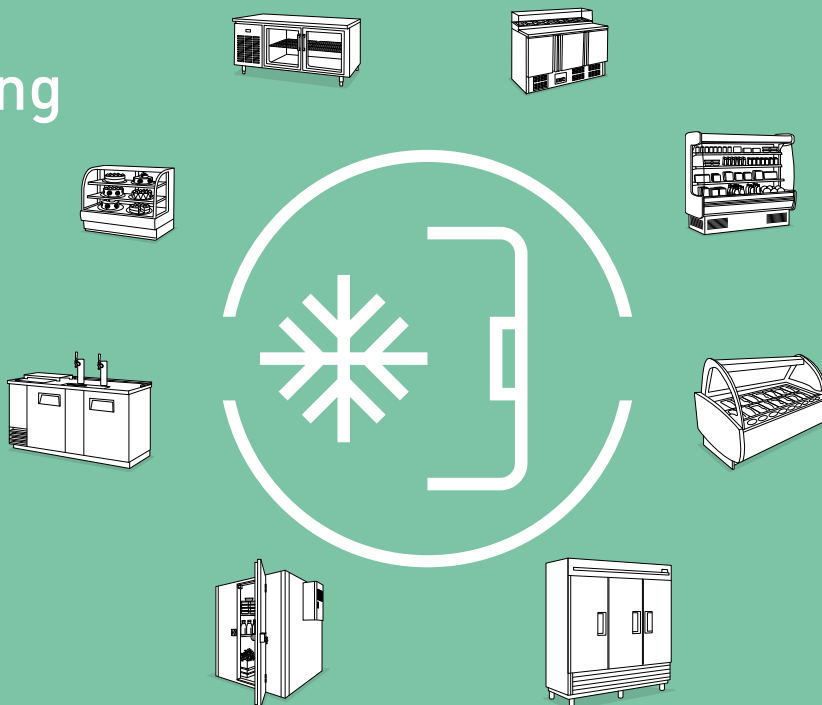









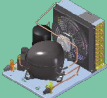

Condensing Units



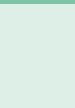

Stationary Cooling

Product Portfolio

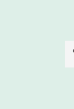
Series	Displacement (cm ³)	Cooling Capacity		Refrigerants
		LBP (W) EN 13215*	MBP (W) EN 13215*	
T D KL	  3.9 – 7.7	 184 – 422	 239 – 700	R134a, R513A R404A, R452A R290
N	  6.1 – 12.6	 159 – 582	 326 – 996	R134a, R513A R404A, R452A R290
S	  10.3 – 21.0	 590 – 944	 752 – 1683	R134a, R513A R404A, R452A R449A, R290
G	 26.3 – 33.8	 1275 – 1712	 1372 – 1782	R134a, R513A R404A, R452A R449A

0 – 35 0 – 2000 0 – 3500



BEYOND THE PRODUCT

Premium Customer Support

- Sales team aligned to customers
- Support in 50+ countries
- Customer service support in different regions
- Worldwide distribution network
- Application engineering worldwide support



Committed to Quality Products

- Preventive quality tools (PPAP, APQP, FMEA ...)
- TS tools (SPC, product and process audits ...)
- Efficient quality control systems
- Field quality and application engineers

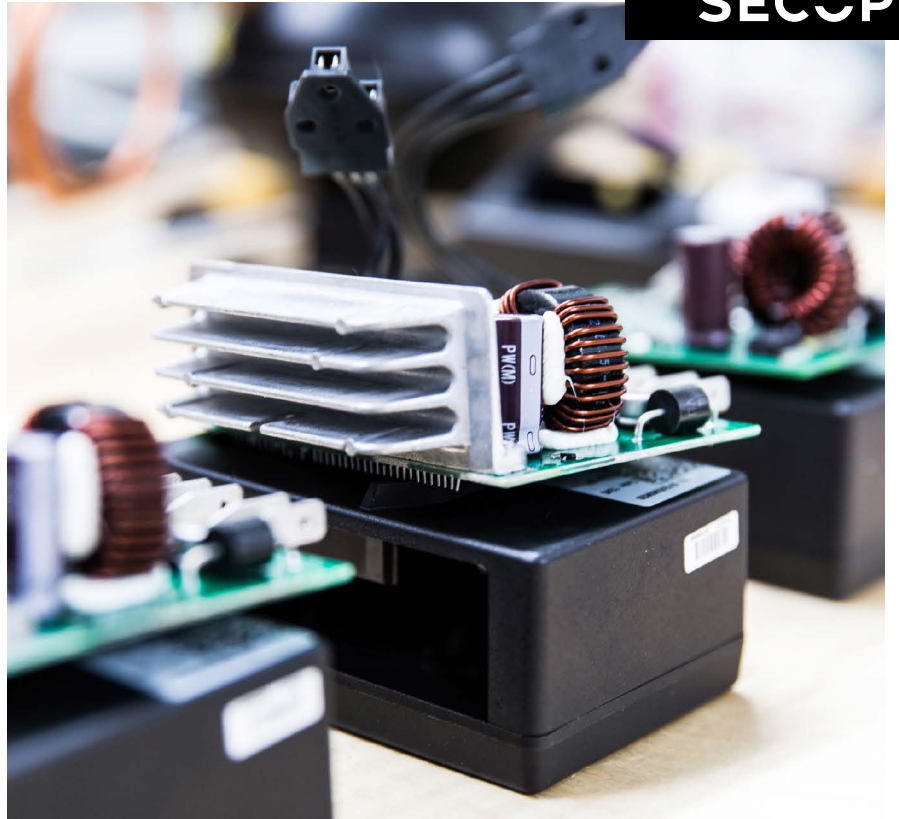

Leading Edge Application Engineering

- Testing for customer's appliances
- Advanced trouble shooting
- System optimization support
- Support conversions to HC refrigerants
- System knowledge to support the introduction of variable-speed solutions



Research and Development

Rooted knowledge in mechanics, electrical motors, electronic controls, and thermodynamics development

- 12 international partners for advanced development
- 33 laboratories located in Austria, Germany, Slovakia, China, US, and Turkey
- 160 R&D engineers and technicians
- 440 patents globally



Advanced Electronics and Controls

- Unparalleled competency in motor design and variable-speed control
- Advanced motor and inverter electronics development
- Simulation tools and innovative design systems

SECCOP



HISTORY AND MILESTONES

The Danfoss Compressors Era

1956

Founded in
Flensburg,
Germany

1977

Mobile cooling
is introduced

1989

100 Million
compressors
produced

1993

Production of first
natural refrigerant
compressors begins

1998

Introduction
variable-speed
compressors

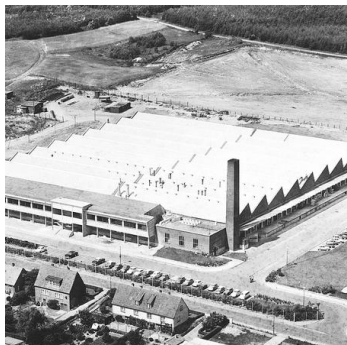

The Secop Era

2010

BD Micro

2015

Energy-optimized
DLE and NLE
propane
compressors

2016

DLV-CN
variable-speed
propane
compressors

2017

NLV-CN
variable-speed
propane
compressors

2020

SLVE18CN
variable-speed
propane
compressor

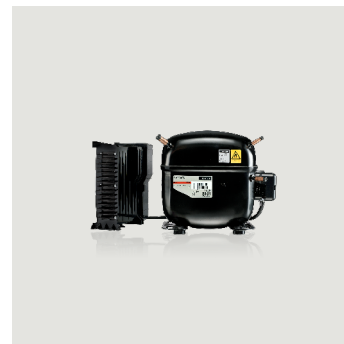
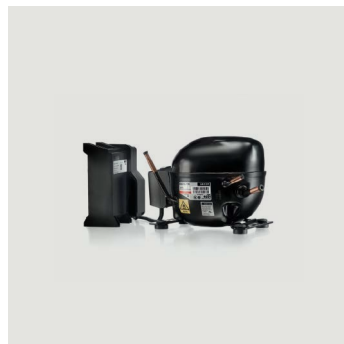
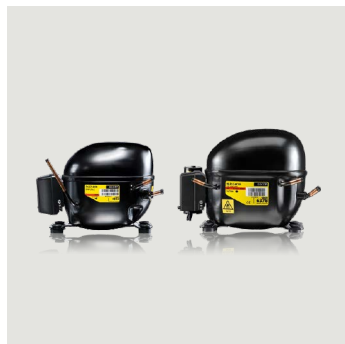

The Secop Era

2021

ULT compressors
for medical cold
chain solutions

2022

KL-Series
A new premium
propane solution

BD Nano-Series
next-generation
mobile cooling
compressors

2023

Modular electronic
MP and XT
controllers

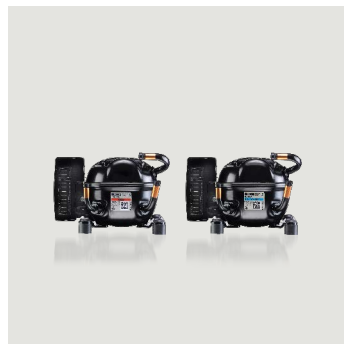
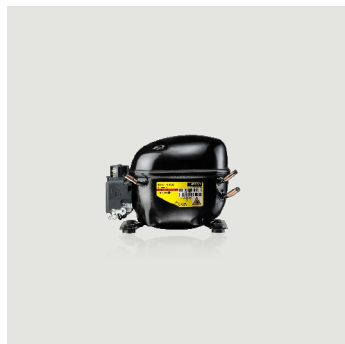
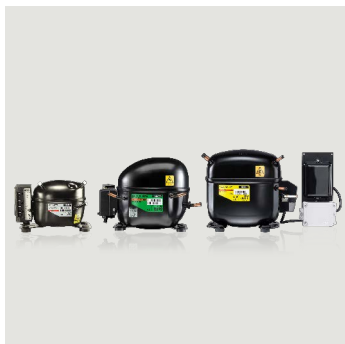

SECCOP

TODAY

Locations, Footprint, and Figures Today

- Headquarters in Germany
- Production facilities in China and Slovakia
- 1,350 employees



6,000,000

compressors produced yearly

Management Board



Dr. Jan Ehlers
Chief Executive Officer



Johannes Maerz
Chief Operation Officer



Michael Engelen
Chief Financial Officer



Norbert Brath
Chief Technology Officer

Thank You for
Your Attention

