

WE HAVE MORE THAN 40 YEARS OF EXPERIENCE DEVELOPING DIRECT CURRENT COMPRESSORS AND HELPING CUSTOMERS BENEFIT FROM THE OPPORTUNITIES OF MOBILE REFRIGERATION TECHNOLOGY.

WITH IN-DEPTH KNOWLEDGE OF USE ACROSS VARIOUS APPLICATIONS, WE HAVE EARNED A POSITION AS MARKET LEADER, WORKING WITH OEM CUSTOMERS.



SERVICE COMES IN MANY DEGREES
BATTERIES ONLY NEED 25°C

APPLICATION NOTE



250W

SAVED EVERY HOUR

EXTEND THE LIFE OF YOUR BATTERIES AND ENSURE MAXIMUM UPTIME IN TELECOMMUNICATION COOLING APPLICATIONS WITH OPTIMISED BATTERY DRIVEN 48 V DC COMPRESSORS. LOW LIFETIME COSTS ENABLE PAYBACK AS FAST AS 14 MONTHS

14

MONTHS PAYBACK TIME

POSSIBLE BY INCREASING BATTERY LIFETIME BY 25%, REDUCING SYSTEM COMPLEXITY AND ENSURING HIGH COP WITH ENERGY SAVING DESIGN



People do not care about deserts, hillsides, rooftops or unstable power supplies.
All they want is a strong signal on their mobile phone.

Uptime

Online/Uptime

In today's global environment the ability to get in touch with others is equally important in remote areas as it is in big cities. High speed mobile data and voice communication connect people in virtually every corner of the world instantly.

With base stations often placed in remote areas and in different environmental conditions, ensuring maximum uptime is a challenge for all telecom service providers.

Each location has its own unique challenges with respect to grid stability, power supply, heat, cold, humidity and dust. How telecom providers meet

these challenges can make or break their success in a highly competitive market.

Shelter cooling

Regardless of location it is crucial that the electronics in the base stations do not overheat. When connected to the power grid this is usually handled by a cooling unit that ensures a stable operating temperature, usually around 32 °C.

Cooling is typically achieved with ventilation or compressor based cooling systems, or a combination of the two. These systems run on AC power, and are well suited to locations close to stable power grids.

WHAT HAPPENS WHEN THE SUN SETS, THE WIND DROPS AND THE TANK IS EMPTY?

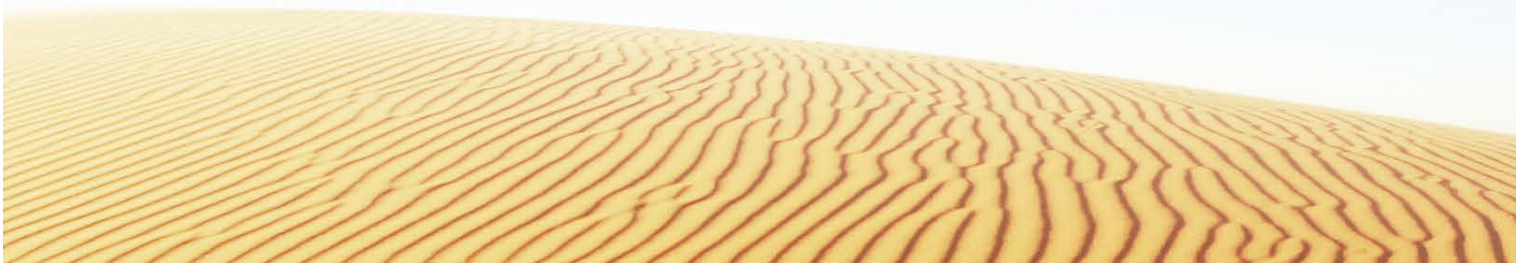

In more remote locations a reliable power supply is not always possible. Power can come from a variety of sources such as solar panels, wind turbines or even a diesel generator.

Avoid unnecessary battery drain

Battery backup is typically used when the main power supply fails, for example when there is no power grid or where the grid is unstable due to grid failure. In such cases batteries become the main power source until the normal electrical supply resumes.

Although convenient, batteries are expensive to buy and replace. They are also a challenge to handle, due to the fact that storing them at high temperatures significantly reduces their lifetime.

The optimal temperature for batteries is 25 °C. Anything above this will shorten their life expectancy and provide their owners with an inconvenient replacement cost.



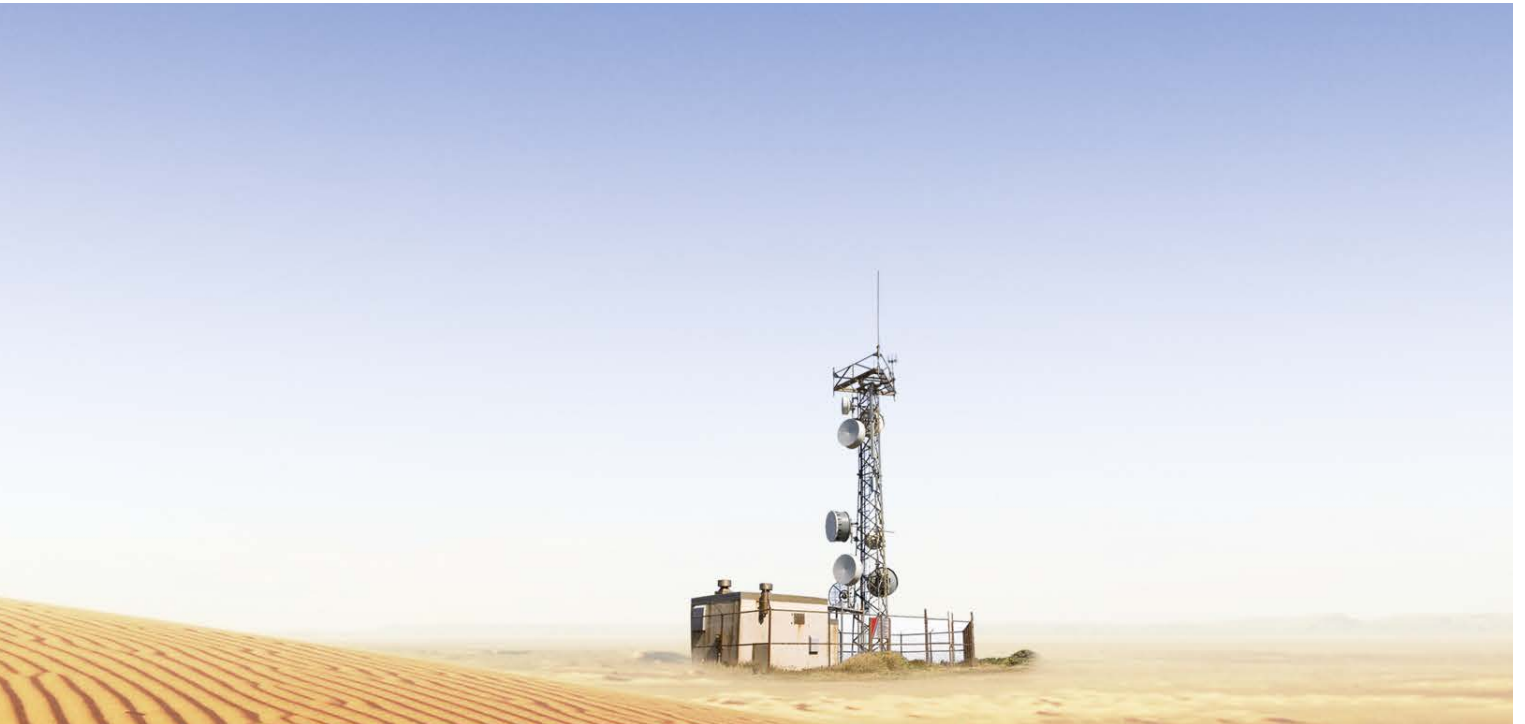

In some geographical regions, the batteries will experience temperatures 20-30 degrees above 25 °C, reducing their lifetime to a mere 25 % compared to batteries that are kept within optimal temperatures.

In fact, for approximately every 10 degrees the temperature around the batteries increases, their lifetime can drop by as much as 50 %.

Optimal battery cooling

A key issue for the base station's overall performance is that the batteries are stored in an environment that will provide maximum cost efficiency and performance.

A few years ago battery packs were typically placed in the same areas as the electronics systems. Such base stations were kept at 25 °C to ensure that the lifetime of the batteries was maintained.

This is somewhat lower than the required temperature for the electronics in the switch boards, which can comfortably handle temperatures of around 32-40 °C.

In recent years designers have therefore begun to move the battery packs outside, allowing the cooling system to ensure the optimal temperature for both electronics and batteries.

Battery bank inside
Shelter maintained at 25 °C

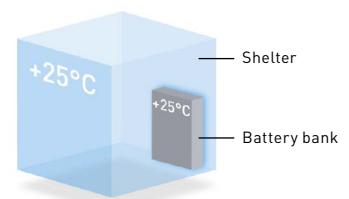

Battery bank outside
Shelter maintained at 32 °C and
battery bank maintained at 25 °C

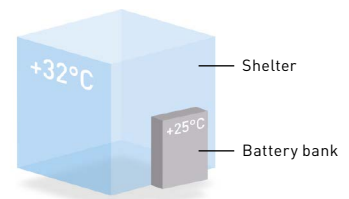

REDUCE ENERGY CONSUMPTION



- Save 250 W per hour
- No power loss in DC/AC conversion
- High COP
- Runs on any power source, eg. sun and wind
- Optimize further with variable speed control

INCREASE BATTERY LIFETIME

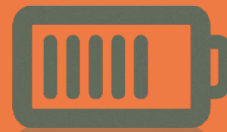

- Maintain optimal temperature (25 °C) independent of grid supply
- Failure detection can automatically alert service team if cooling system malfunctions

SIMPLIFY SYSTEM DESIGN



- Reduce overall costs by using fewer parts
- Integrated fan control
- Integrated electronic thermostat
- Direct connection to batteries without converter

Energy saving technology provides system-wide advantages

Save 250W per hour

When power fails battery cooling systems need to draw on the batteries' power. As the compressor is the main power consumer, much can be gained with a solution that is extremely efficient without being overly power hungry.

By using a battery powered direct current (DC) compressor, it is possible to build a cooling system that can run on batteries, solar cells and wind turbines without needing conversion to alternating

current (AC). The BD250GH.2 and BD350GH compressors are unique as they are constructed with an integrated fan control and an electronic thermostat. This way it is possible to simplify the design of the overall system and still ensure maximum performance.

With battery drain being a big issue, it is important to use an energy efficient compressor with as high a COP as possible, compared to other solutions that rely on AC and 230 V AC conversion, the BD250GH.2

REDUCE SERVICE COSTS

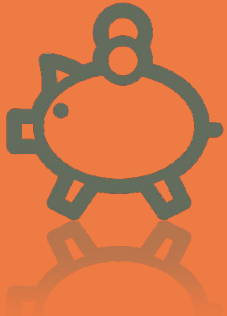

- Reduce risk of failure with integrated design
- Easy connectivity enables fast replacement
- Market leading reliability tested in advanced laboratories
- Safety features avoid wrong settings
- Automatic failure detection

IMPROVED HIT RATE IN PROJECTS



- Improve your hit rate in project sales by offering the best solution available that also reduces your sales cost per project
- Fewer parts in system
- Overall improvement in energy efficiency
- Reliable cooling solution
- Longer battery lifetime

SAVE TIME ON INSTALLATION

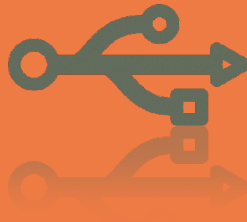

- Integrated design with compressor, fan controller and thermostat in a single unit

QUALITY HANDLING AND SERVICE



- High level of application knowledge among Secop service team
- Single point of contact for service and support
- Fewer part numbers to order and handle
- Keep smaller stocks

and BD350GH compressors save up to 250 W per hour.

In areas that rely on battery power for up to 16 hours a day, you can be certain that Secop BD compressors will ensure that batteries will last as long as possible.



Technical data

General (code numbers)	BD250GH.2	BD350GH
Compressor (without electronic unit)	101Z0405	102Z3031
Electronic unit	101N0732	101N0720

Application		
Application	LBP/MBP/HBP	
Evaporating temperature	°C	-25 to 15
Voltage/max. voltage	V DC	48/60

Performance data (EN12900/CECOMAF • BD250GH.2: 53 V DC • BD350GH: 56 V DC • max. speed)										
Evaporating temperature	°C	-25	0	5	15	-25	0	5	15	
Cooling capacity	W	64.3	261	322	472	121	436	535	781	
Power consumption	W	72.4	143	160	196	131	265	294	352	
Current consumption	A	1.36	2.86	3.17	3.76	2.34	4.73	5.25	6.28	
COP	W/W	0.89	1.82	2.01	2.41	0.92	1.64	1.82	2.22	

Performance data (EN12900/CECOMAF • BD250GH.2: 53 V DC • BD350GH: 56 V DC • max. speed)										
Evaporating temperature	°F	-13	32	41	59	-13	32	41	59	
Cooling capacity	BTU/h	273	1103	1364	2008	511	1842	2265	3317	
Power consumption	W	72	143	159	195	131	263	292	349	
Current consumption	A	1.37	2.86	3.16	3.75	2.33	4.70	5.21	6.23	
EER	BTU/Wh	3.77	7.73	8.57	10.28	3.91	7.00	7.76	9.51	

Dimensions				
Height	mm	A	137	173
		B	135	169
Suction connector	location/I.D. mm angle	C	6.2 40°	6.2 90°
		material seal	Cu-plated steel Al cap	
Process connector	location/I.D. mm angle	D	6.2 45°	6.2 31.5°
		material seal	Cu-plated steel Al cap	
Discharge connector	location/I.D. mm angle	E	5.0 21°	5.0 28°
		material seal	Cu-plated steel Al cap	
Connector tolerance	I.D. mm		±0.09, on 5.0 +0.12/+0.20	

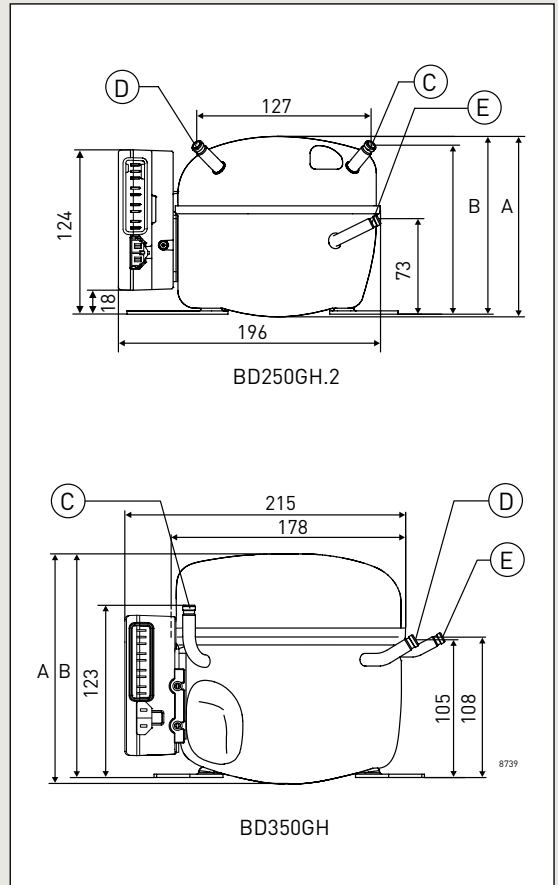

Base stations introduction

Base stations used for mobile phones bring certain opportunities for compressor cooling. Especially those base stations situated in tropical and sub-tropical areas, where high ambient temperatures requires active cooling of some kind.

Shelter cooling

The heat generated in electrical power components needs to be removed in order to keep temperatures below approx. 80 °C.

This often means that spot cooling or cooling of the racks is required. It is not always sufficient to solely ventilate and cool the room.

Battery cooling

As "up-time" of the base stations is very important, a battery back-up package of a certain size (200 Ah to 1500 Ah) is normally used to secure power supply to the base station in case of grid power failure.

The lifetime of these big and expensive packages depends very much on the temperature of the batteries. To keep the temperature at an acceptable level, a small refrigeration system is normally attached directly to the battery rack.

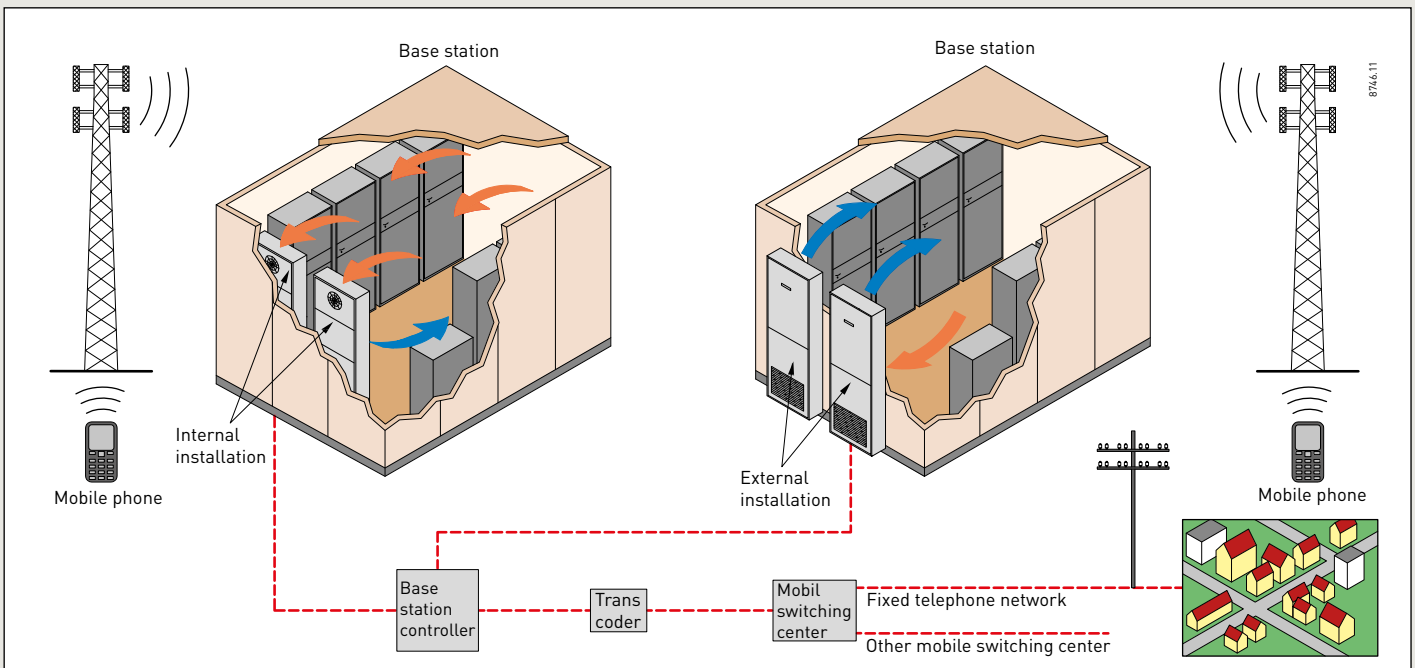

Schematic of a base station incl the full network

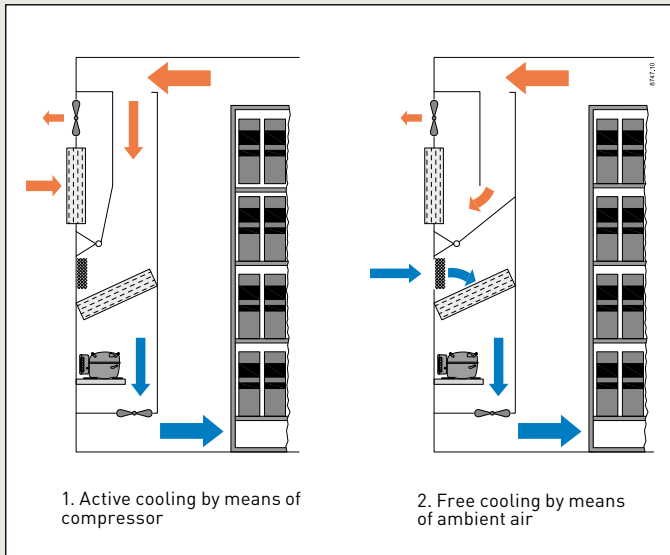

Shelter cooling – free cooling and active cooling combination

In order to save energy, shelter cooling is often designed to have two operation modes.

1. Active cooling
2. Free cooling

Active cooling

A traditional cooling form by means of a refrigeration system. It is used when the ambient temperature is higher than the temperature inside the shelter. Cooling is controlled by a thermostat.

Free cooling

A cooling form where the outside air is used to cool the shelter. It is used when ambient temperature is lower than the temperature inside the shelter. When the outside temperature is lower, the compressor cooling system is stopped and a damper opens for outside air to be blown into the shelter.

In order to avoid allowing humid air into the shelter, a humidity sensor is also used to control the damper. Temperature and humidity must be at a certain low level before free cooling can take place.

Battery cooling system design

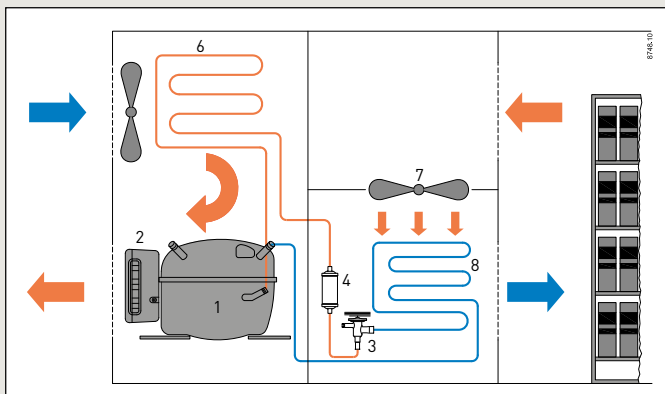

The battery cooler is typically designed as a clip-on unit to be very compact. Piping could be done as shown in the drawing above.

1. BD250GH.2/BD350GH compressor
2. Electronic unit for compressor
3. Thermostatic expansion valve
4. Combined filter drier and receiver
5. Condenser fan
6. Condenser
7. Evaporator fan
8. Evaporator

Battery cooling – selection of components

The refrigeration system main components are:

- Compressor
- Condenser
- Receiver and filter drier
- Expansion device
- Evaporator

Compressor

Depending on the cooling demand, a **BD250GH.2** or a **BD350GH** can be selected.

A **BD250GH.2** compressor offers cooling capacity from **330 to 590 W**.

A **BD350GH** compressor offers cooling capacity from **650 to 970 W**.

(@+15 °C evap. temp., ASHRAE LBP)

Both compressors can be powered with DC in the range from 32 to 60 V DC. Via the PC software tool **TOOL4COOL®** it is possible to customize all settings such as evaporator and condenser fan control, set the electronic thermostat and select the desired capacity of the compressor.

Condenser

The condenser should be of the fin & tube type or alternatively a micro-channel type. Sizing of the condenser depends on heat rejection. The condenser will normally be placed in front of the compressor ensuring that the airflow goes through the condenser before it passes over the compressor.

Expansion device

There are two types of expansion devices that can be applied to this application, capillary tube or thermostatic expansion valve (TXV).

An expansion valve is generally the best solution as it will secure optimum utilization of the evaporator under all load conditions. When a TXV is applied it is important that there is a small liquid receiver in the system to handle liquid variation due to load variations.

Danfoss for example offers a whole range of TXV valves. For the telecom application a TXV type TUB (fixed orifice) or TD 1 can be recommended. For a receiver and filter drier, Secop offers a combined drier and receiver type DMC in different sizes depending on the capacity of the system.

Although, a capillary tube is a cheaper solution, the capillary tube is optimized to one certain load condition and will give too little or too much liquid during load variations which means the evaporator is not always fully utilized. Secondly the amount of refrigerant charge must be optimized to the system. Something that needs experience and skills to do.

Evaporator

The evaporator should be of the type fin and tube with forced air that can throw evenly distribute the air through the whole space.

A 48 V DC fan motor is recommended in order to take advantage of the electronic unit to control fan speed and thereby save energy.



MAXIMIZE UPTIME & REDUCE RUNNING COSTS IN TELECOM COOLING APPLICATIONS

When the power fails, battery cooling systems must draw on the batteries' power. As the compressor is the main power consumer, much can be gained with a solution that is extremely efficient without being overly power hungry.

By using a battery-powered direct current (DC) compressor, it is possible to build a cooling system that can run on batteries, solar cells, and wind turbines without needing to convert to alternating current (AC).

The BD250GH.2 and BD350GH compressors are unique as they are constructed with integrated fan control and electronic thermostat. In this way, it is possible to simplify the design of the overall system and still ensure maximum performance.

With battery drain being a big issue, it is important to use an energy-efficient compressor with the highest COP possible.

Compared to other solutions that rely on AC and 230 V AC conversion, the BD250GH.2 and BD350GH compressors save up to 250 W per hour.

In areas that rely on battery power for up to 16 hours a day, you can be certain that Secop BD compressors will ensure that batteries will last as long as possible.

The optimal temperature for batteries is 25°C. Anything above this will shorten their life expectancy and provide their owners with an inconvenient replacement cost.

OUR JOURNEY SO FAR

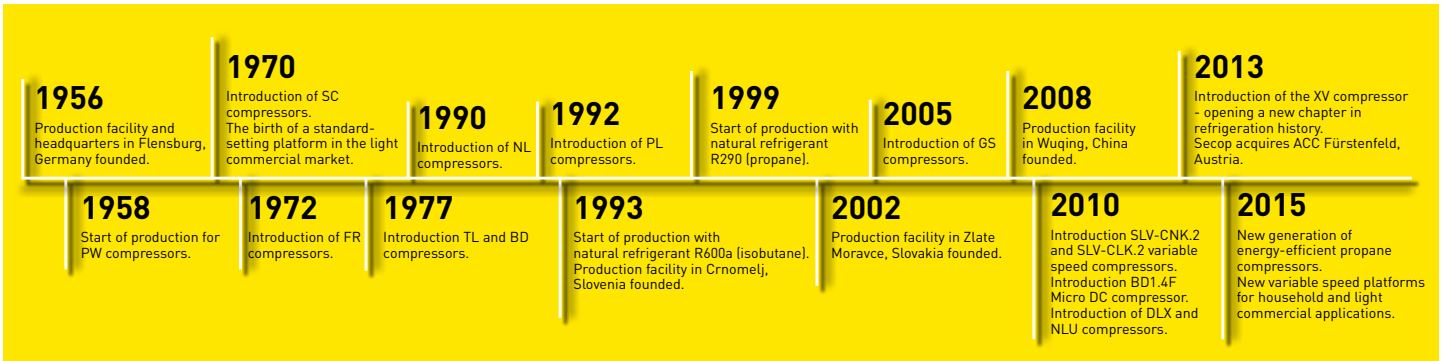

Secop GmbH · Mads-Clausen-Str. 7 · 24939 Flensburg · Germany · Tel: +49 461 4941 0 · www.secop.com

Secop accepts no responsibility for possible errors in catalogs, brochures, and other printed material. Secop reserves the right to alter its products without notice. This also applies to products already on order provided that such alterations can be made without subsequent changes being necessary to specifications already agreed. All trademarks in this material are the property of the respective companies. Secop and the Secop logotype are trademarks of Secop GmbH. All rights reserved.